

Gear Couplings

RINGFEDER® TNZ ZCAV / TNZ ZCBV

Vertical construction

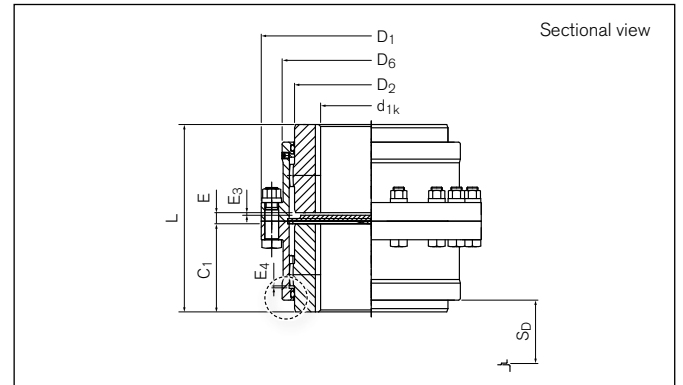
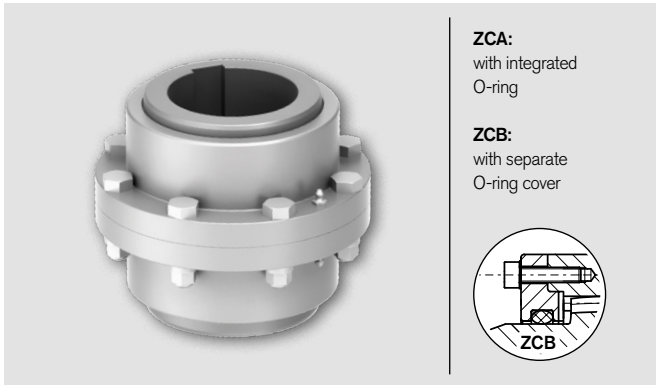

Identifier		Size	T _{KN}	T _{Kmax}	n _{max}	d _{1k} min-max	d _{2k} min-max	D ₁	D ₂	D ₆
ZCAV	ZCBV		Nm	Nm	1/min	mm	mm	mm	mm	mm
XC2606	---	69	1750	3500	6000	12 - 50	12 - 50	111	69	81,5
XC2608	---	85	2750	5500	4600	18 - 60	18 - 60	152	85	103,5
XC2610	XC3610	107	5500	11000	4200	28 - 75	28 - 75	178	107	127,5
XC2613	XC3613	133	8500	17000	4000	40 - 95	40 - 95	213	133	156
XC2615	XC3615	152	13500	27000	3850	50 - 110	50 - 110	240	152	181
XC2617	XC3617	179	22000	44000	3700	60 - 130	60 - 130	280	179	209
XC2620	XC3620	209	35000	70000	3200	70 - 155	70 - 155	318	209	245,5
XC2623	XC3623	234	43000	86000	2900	85 - 175	85 - 175	346	234	274
XC2625	XC3625	254	68000	136000	2600	95 - 190	95 - 190	389	254	307
XC2627	XC3627	279	82000	164000	2300	110 - 210	110 - 210	425	279	334,5
XC2630	XC3630	305	150000	300000	2100	120 - 230	120 - 230	457	305	366
XC2635	XC3635	355	195000	390000	1800	130 - 270	130 - 270	527	355	423

Identifier		Size	C ₁	E	E ₃	E ₄	L	S _D	ΔK _r	ΔK _w	J	V _{GR}	G _{w_{sb}}
ZCAV	ZCBV		mm	mm	mm	mm	mm	mm	mm	degree	10 ⁻³ kgm ²	dm ³	kg
XC2606	---	69	43	7	1,5	1,5	93	30	0,42	2 x 0,5	4	Follow lubrication instruction	4,1
XC2608	---	85	50	8	1,5	1,5	108	37	0,51	2 x 0,5	18		8,8
XC2610	XC3610	107	62	11	1,5	1,5	135	48	0,66	2 x 0,5	40		14,8
XC2613	XC3613	133	76	12	2,5	2,5	164	56	0,77	2 x 0,5	102		25,8
XC2615	XC3615	152	90	16,5	5,5	2,5	196	70	0,99	2 x 0,5	187		37,9
XC2617	XC3617	179	105	15	3	3	225	79	1,15	2 x 0,5	407		60,2
XC2620	XC3620	209	120	18	6	3	258	92	1,33	2 x 0,5	801		89,9
XC2623	XC3623	234	135	23	9	4	293	103	1,5	2 x 0,5	1248		117,9
XC2625	XC3625	254	150	34	20	4	334	120	1,75	2 x 0,5	2370		168,2
XC2627	XC3627	279	175	36	22	4	386	136	1,99	2 x 0,5	3638		221,8
XC2630	XC3630	305	190	38	24	4	418	148	2,16	2 x 0,5	4830		269,3
XC2635	XC3635	355	220	48	32	5	488	174	2,55	2 x 0,5	10022		421,7

- Examine the load capacity of the shaft-hub connection
- Hubs pilot bored, bore diameter 2 mm smaller than smallest finish bore diameter

Distance E may not vary during operation

To continue see next page

Gear Couplings RINGFEDER® TNZ ZCAV / TNZ ZCBV

Explanation

T_{KN}	= Nom. Transmissible torque	D₁	= Outer diameter	L	= Total length
T_{Kmax}	= Max. transmissible torque of the coupling	D₂	= Outer diameter hub	S_D	= Disassembly Space
n_{max}	= Max. rotation speed	D₆	= Diameter	ΔK_r	= Max. permissible radial misalignment
d_{1kmin}; d_{2kmin}	= Min. bore diameter d ₁ /d ₂ with keyway acc. to DIN 6885-1	C₁	= Guided length in hub bore	ΔK_w	= Max. permissible angular misalignment
d_{1kmax}; d_{2kmax}	= Max. bore diameter d ₁ /d ₂ with keyway acc. to DIN 6885-1	E	= Gap width between left and right component	J	= Total moment of inertia
		E₃	= Gap width	V_{GR}	= Grease volume
		E₄	= Gap width	Gw_{sb}	= Weight at smallest bore diameter

Ordering example

Identifier	Size	d _{1k}	d _{2k}	Further details
XC3630	305	140	220	*

¹⁾ Without any other specification, we deliver as a standard: keyway acc. to DIN 6885-1, keyway side fit P9, bore tolerance H7; optional with set screw

Further information on
RINGFEDER® TNZ ZCAV / TNZ ZCBV
 on www.ringfeder.com

Disclaimer of liability

All technical details and notes are non-binding and cannot be used as a basis for legal claims. The user is obligated to determine whether the represented products meet his requirements. We reserve the right carry out modifications at any time in the interests of technical progress.