

Gear Couplings

RINGFEDER® TNZ ZCAU / TNZ ZCBU

Standard hub and extended universal hub

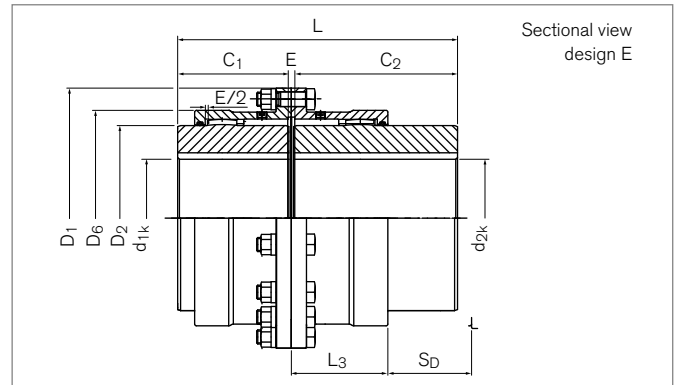
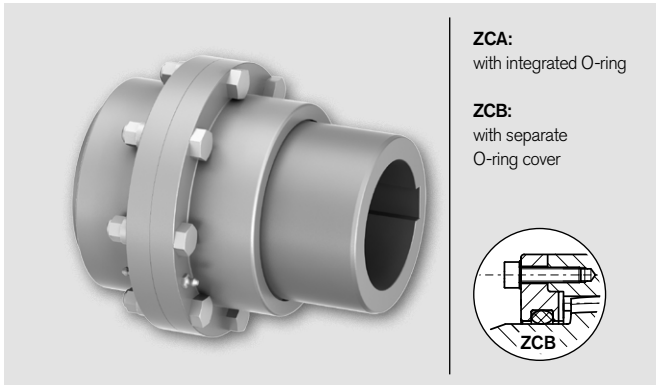

Identifier		Size	T _{KN}	T _{Kmax}	n _{max}	d _{1k} min-max	d _{2k} min-max	D ₁	D ₂	D ₆	C ₁	C ₂
ZCAU	ZCBU		Nm	Nm	1/min	mm	mm	mm	mm	mm	mm	mm
XC2206	---	69	1750	3500	6000	12 - 50	12 - 50	111	69	81,5	43	105
XC2208	---	85	2750	5500	4600	18 - 60	18 - 60	152	85	103,5	50	115
XC2210	XC3210	107	5500	11000	4200	28 - 75	28 - 75	178	107	127,5	62	130
XC2213	XC3213	133	8500	17000	4000	40 - 95	40 - 95	213	133	156	76	150
XC2215	XC3215	152	13500	27000	3850	50 - 110	50 - 110	240	152	181	90	170
XC2217	XC3217	179	22000	44000	3700	60 - 130	60 - 130	280	178	209	105	185
XC2220	XC3220	209	35000	70000	3200	70 - 155	70 - 155	318	209	245,5	120	215
XC2223	XC3223	234	43000	86000	2900	85 - 175	85 - 175	346	234	274	135	245
XC2225	XC3225	254	68000	136000	2600	95 - 190	95 - 190	389	254	307	150	295
XC2227	XC3227	279	82000	164000	2300	110 - 210	110 - 210	425	279	334,5	175	300
XC2230	XC3230	305	150000	300000	2100	120 - 230	120 - 230	457	305	366	190	305
XC2235	XC3235	355	195000	390000	1800	130 - 270	130 - 270	527	355	423	220	310

Identifier		Size	E	E _{I1}	L	L _{I1}	L ₃	S _D	ΔK _r	ΔK _w	J	V _{GR}	G _{w_{sb}}
ZCAU	ZCBU		mm	mm	mm	mm	mm	mm	mm	degree	10 ⁻³ kgm ²	dm ³	kg
XC2206	---	69	3	5	151	153	39	80	0,42	2 x 0,5	5	0,07	5,8
XC2208	---	85	3	8	168	173	46	83	0,51	2 x 0,5	18	0,08	11,2
XC2210	XC3210	107	3	14	195	206	59	85	0,66	2 x 0,5	40	0,13	18,6
XC2213	XC3213	133	5	12	231	238	69	100	0,77	2 x 0,5	120	0,22	32,3
XC2215	XC3215	152	5	24	265	284	83	106	1,00	2 x 0,5	220	0,38	46,7
XC2217	XC3217	179	6	27	296	317	93	115	1,15	2 x 0,5	469	0,58	72,0
XC2220	XC3220	209	6	32	341	367	106	132	1,33	2 x 0,5	939	0,75	110,1
XC2223	XC3223	234	8	37	388	417	118	151	1,5	2 x 0,5	1498	1,25	146,4
XC2225	XC3225	254	8	50	453	498	138	181	1,75	2 x 0,5	2827	1,92	213,4
XC2227	XC3227	279	8	53	483	528	154	185	1,99	2 x 0,5	4209	2,67	266,8
XC2230	XC3230	305	8	58	503	553	166	178	2,16	2 x 0,5	5580	3,33	317,9
XC2235	XC3235	355	10	72	540	602	193	174	2,55	2 x 0,5	11104	5,00	470,3

- Examine the load capacity of the shaft-hub connection
- Hubs pilot bored, bore diameter 2 mm smaller than smallest finish bore diameter

With inverted standard hub note EI1 and LI1

To continue see next page

Gear Couplings RINGFEDER® TNZ ZCAU / TNZ ZCBU

Explanation

T_{KN}	= Nom. Transmissible torque	D₂	= Outer diameter hub	L_H	= Complete length of inverted variant 1/2
T_{Kmax}	= Max. transmissible torque of the coupling	D₆	= Diameter	L₃	= Length
n_{max}	= Max. rotation speed	C₁	= Guided length in hub bore	S_D	= Disassembly Space
d_{1kmin}; d_{2kmin}	= Min. bore diameter d ₁ /d ₂ with keyway acc. to DIN 6885-1	C₂	= Guided length in hub bore	ΔK_r	= Max. permissible radial misalignment
d_{1kmax}; d_{2kmax}	= Max. bore diameter d ₁ /d ₂ with keyway acc. to DIN 6885-1	E	= Gap width between left and right component	ΔK_w	= Max. permissible angular misalignment
D₁	= Outer diameter	E_H	= Gap width between left and right component of inverted variant 1/2	J	= Total moment of inertia
		L	= Total length	V_{GR}	= Grease volume
				Gw_{sb}	= Weight at smallest bore diameter

Ordering example

Identifier	Size	d _{1k}	d _{2k}	Further details
XC3215	152	90	110	*

¹⁾ Without any other specification, we deliver as a standard: keyway acc. to DIN 6885-1, keyway side fit P9, bore tolerance H7; optional with set screw

Further information on
RINGFEDER® TNZ ZCAU / TNZ ZCBU
 on www.ringfeder.com

Disclaimer of liability

All technical details and notes are non-binding and cannot be used as a basis for legal claims. The user is obligated to determine whether the represented products meet his requirements. We reserve the right carry out modifications at any time in the interests of technical progress.